

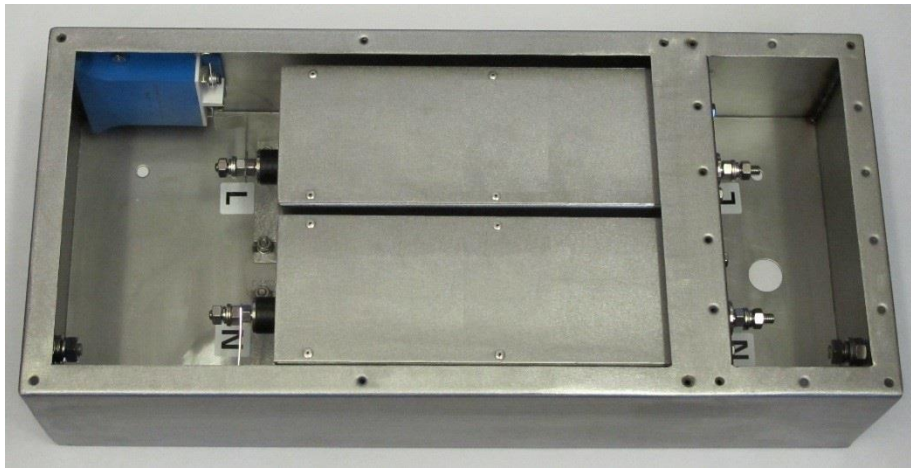

HEMP PROTECTION FILTERS FOR AC MAINS POWER LINES MODULAR OPTION



**MEETS ELECTRICAL POINT-OF-ENTRY
REQUIREMENTS OF MIL-STD-188-125-1 & -2
AND DEF STAN 59-188 PART 1 AND PART 2
FOR SHORT AND INTERMEDIATE PULSES**



MPE Limited
Hammond Road,
Knowsley Industrial Park,
Liverpool
L33 7UL
UK

Specialist EMI Power Line Filters - Issue 2 - April 2022
This information is for guidance only
MPE reserve the right to make changes without notice
© 1994 -2022 MPE Limited

Web: www.mpe.co.uk
E-mail: sales@mpe.co.uk
Tel: +44 (0) 151 632 9100



Standard Range

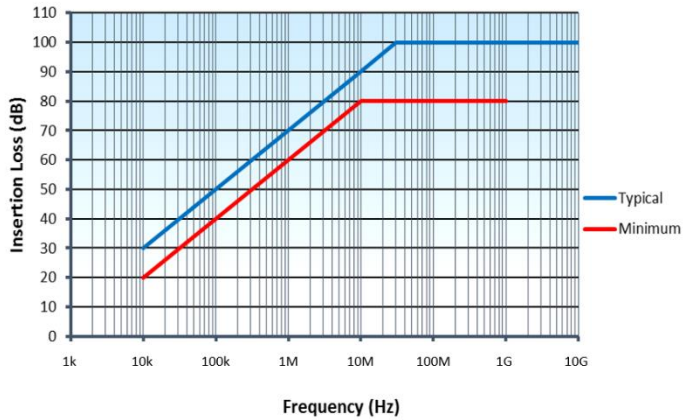

Description

A range of 2 line (for single phase and neutral supplies) and 4 line (for three phase and neutral supplies) HEMP Protection Power Line filters meeting the pulse current injection requirements of Mil-Std-188-125-1 and -2 and Def Stan 59-188 parts 1 and 2 for E1 and E2 pulses. Electrically identical to our standard range of HEMP Protection Power Line Filters but with modular construction allowing for easy replacement of individual lines. The filter modules are housed in an outer box fitted with high-energy transient suppressors for convenient installation.

Each filter in the modular HEMP protection range has been designed to meet or exceed the relevant performance and/or safety criteria defined within these standards:

Mil-Std-188-125
Mil-Std-220C
CISPR 17:2011 / BS EN 55017:2011
BS EN 60950 / IEC 60950
UL 1283

Features

- 440/250Vac with 16A – 400A current ratings
- 480/277Vac versions also available for US
- 2 or 4 individually filtered lines
- Smaller & lighter than traditional solutions
- Lower heat dissipation than traditional solutions
- Robust stainless steel enclosure
- Modular construction with replaceable lines
- Utilise MPE self-healing feedthrough capacitors
- High energy transient suppressors for high reliability
- Very low residual pulse current – high safety margin
- CE marked to Low Voltage Directive 2014/35/EU
- CE marked to RoHS Directive 2011/65/EU



Ratings and Characteristics

Rated Voltage: All filters 4 line (3 phase) filters	250Vac 50/60 Hz or 300V dc each line to case 440/250Vac 50/60Hz (480/277Vac on request)
Test Voltage (prior to fitting transient suppressors)	2250Vdc each line to case
Insulation Resistance	>100MΩ (Prior to fitting discharge resistors)
Discharge Resistors	Fitted internally from each line to case
Discharge Time to below 34V	<30s
Maximum Temperature Rise on Full Load	25°C
Full Load Operating Temperature Range	-40°C to +50°C
Storage Temperature Range	-40°C to +85°C
Leakage Current at 250Vac 50Hz	<1.5A for 16A - 63A Filters, <5A for 100A - 250A Filters, <8A for 400A Filters
Peak Surge Current of Transient Suppressors	70kA (8/20μs)
Varistor Voltage Rating: 440/250Vac version 480/277Vac version	275Vac 480Vac

Insertion Loss Performance

Minimum insertion loss in 50Ω system with / without load						
Frequency	10kHz	100kHz	1MHz	10MHz	100MHz	1GHz
Insertion loss	20dB	40dB	60dB	80dB	80dB	80dB

Transient Suppression Performance (440/250Vac version)

MIL STD 188-125-1 acceptance test, short pulse current injection, wave shape 20/500ns					
Input pulse amplitude	250A	500A	1000A	1800A	2500A
MIL-STD-188-125 residual requirement	<10A	<10A	<10A	<10A	<10A
Typical filter residual let-through	<1.5A	<2A	<3A	<3.5A	<4.5A

MIL STD 188-125-1 acceptance test, intermediate pulse current injection, wave shape 1.5/3000μs	
Input pulse amplitude	250A
MIL-STD-188-125 requirement	No filter damage or performance degradation
Typical filter response	No filter damage or performance degradation



Product Range

Part Number	Current Rating per Line @ 50°C (A) *	Number of Lines	DC Volt Drop per Line max (V)	Maximum Heat Dissipation (W)	Major Dimensions (mm)			Weight Approx. (kg)
					Length A	Width B	Depth C	
DS33711	16	2	0.2	10	435	260	115	12
DS33712	32	2	0.2	20	560	260	140	17
DS33713	63	2	0.3	40	630	340	190	36
DS33714	100	2	0.2	65	760	390	230	48
DS33715	200	2	0.1	80	850	460	230	84
DS33719	250	2	0.1	90	1200	500	240	90
DS33716	400	2	0.1	130	1560	680	265	150
DS33721	16	4	0.2	20	435	480	115	24
DS33722	32	4	0.2	40	560	480	140	36
DS33723	63	4	0.3	75	630	640	190	66
DS33724	100	4	0.2	125	760	740	230	100
DS33725	200	4	0.1	140	850	880	230	160
DS33729	250	4	0.1	160	1200	960	240	180
DS33726	400	4	0.1	250	1560	1260	265	270

* Current de-rating between 50°C and 85°C: $I_{\theta} = I_R \sqrt{\frac{85-\theta}{35}}$

Dimensions and Mechanical Details 2 Line Filters:

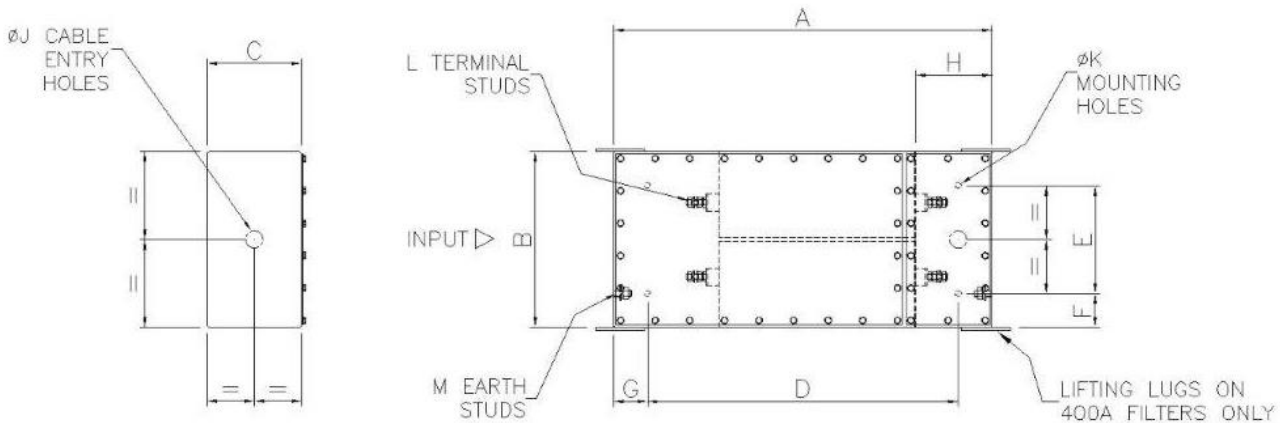

Material: Stainless steel
Finish: Natural

Part Number	Dimensions (mm)											
	A	B	C	D	E	F	G	H	J	K	L	M
DS33711	435	260	115	355	160	50	40	85	20	9	M5	M6
DS33712	560	260	140	460	160	50	50	110	25	9	M8	M10
DS33713	630	340	190	520	230	55	55	120	32	11	M8	M10
DS33714	760	390	230	650	280	55	55	120	32	11	M8	M10
DS33715	850	460	230	700	320	70	75	150	51	17	M12	M16
DS33719	1200	500	240	1000	360	70	100	200	64	17	M16	M20
DS33716	1560	680	265	1200	480	100	180	280	76	17	M20	M20



Dimensions and Mechanical Details 4 Line Filters:

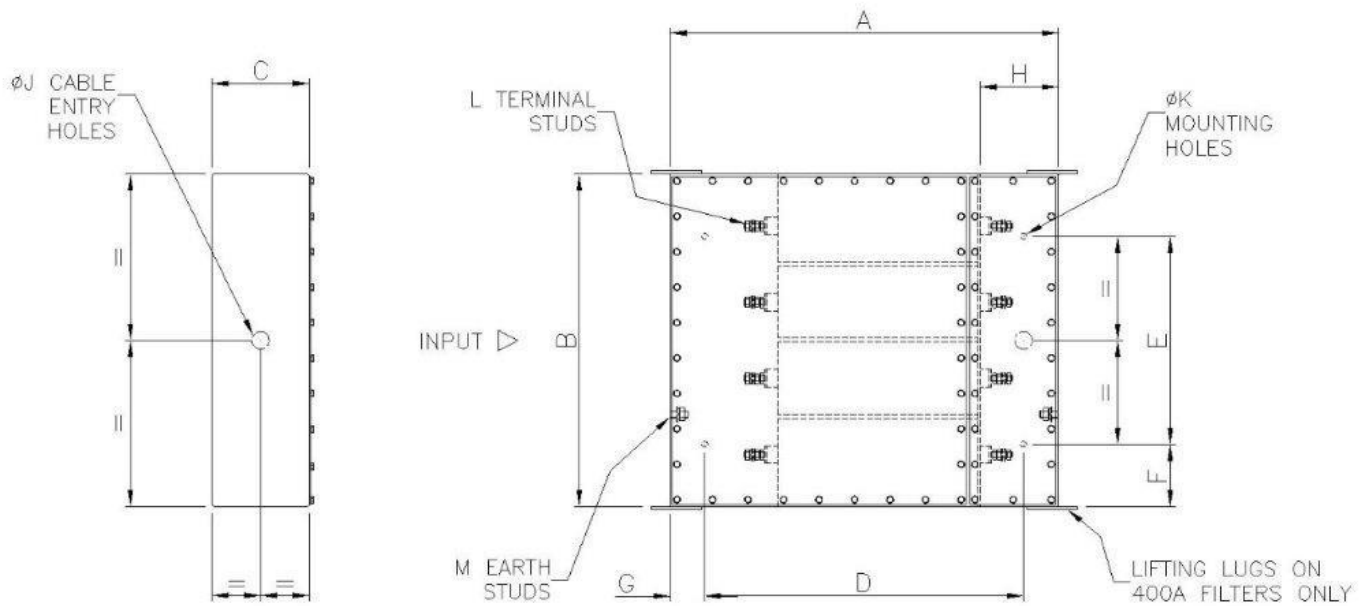

Material: Stainless steel
Finish: Natural

Part Number	Dimensions (mm)											
	A	B	C	D	E	F	G	H	J	K	L	M
DS33721	435	480	115	355	300	90	40	85	20	9	M5	M6
DS33722	560	480	140	460	300	90	50	110	25	11	M8	M10
DS33723	630	640	190	520	410	115	55	120	32	11	M8	M10
DS33724	760	740	230	650	480	130	55	120	32	11	M8	M10
DS33725	850	880	230	700	540	170	75	150	51	17	M12	M16
DS33729	1200	960	240	1000	580	190	100	200	64	17	M16	M20
DS33726	1560	1260	265	1200	720	270	180	280	76	17	M20	M20



Ordering Additional Modules

One benefit of using a modular filter option is the ability to quickly and easily replace an individual filter line. If you require a replacement module or would like to order a spare module please consult the table below:

Module Part Number	Current Rating @ 50°C (A) *	Voltage Rating	To Fit Filter Part Numbers
DS33711MOD	16	250Vac 50/60Hz	DS33711 or DS33721
DS33712MOD	32	250Vac 50/60Hz	DS33712 or DS33722
DS33713MOD	63	250Vac 50/60Hz	DS33713 or DS33723
DS33714MOD	100	250Vac 50/60Hz	DS33714 or DS33724
DS33715MOD	200	250Vac 50/60Hz	DS33715 or DS33725
DS33719MOD	250	250Vac 50/60Hz	DS33719 or DS33729
DS33716MOD	400	250Vac 50/60Hz	DS33716 or DS33726
DS33711MOD/277	16	277Vac 50/60Hz	DS33711/277 or DS33721/480
DS33712MOD/277	32	277Vac 50/60Hz	DS33712/277 or DS33722/480
DS33713MOD/277	63	277Vac 50/60Hz	DS33713/277 or DS33723/480
DS33714MOD/277	100	277Vac 50/60Hz	DS33714/277 or DS33724/480
DS33715MOD/277	200	277Vac 50/60Hz	DS33715/277 or DS33725/480
DS33719MOD/277	250	277Vac 50/60Hz	DS33719/277 or DS33729/480
DS33716MOD/277	400	277Vac 50/60Hz	DS33716/277 or DS33726/480

* Current de-rating between 50°C and 85°C: $I_{\theta} = I_R \sqrt{\frac{85-\theta}{35}}$

Cable Entry/Exit Options

Several different cable entry/exit options are available as shown below. Standard configuration for shielded room mounting is suffix C, end entry, base exit.

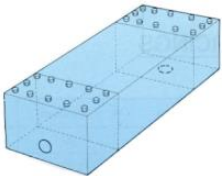

Part No: DSXXXXXC
End entry and base exit

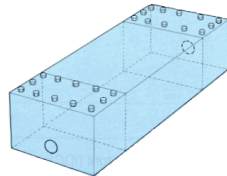

Part No: DSXXXXXA
End entry and end exit

Cable Entry/Exit Options	Suffix
End entry and end exit holes	A
End entry and end exit holes	C
No cable entry/exit holes	X
No cable entry/exit holes or mounting holes	XX

Filter Selection Guide

Step 1 Choose current and number of lines required

Step 2 Select part number and cable entry/exit suffix

Step 3 For US voltage add second suffix /277 for 2 line 277Vac operation or /480 for 4 line 480V/277Vac operation



Installation Details

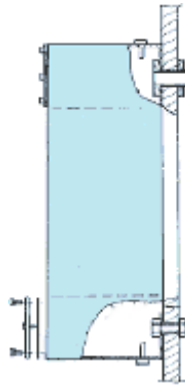

Typical Installation

The mounting surface should be clean and unpainted to ensure a low impedance earth bond and good RF seal. Fixing screws and gland tubes can be supplied as an optional extra.

Recommended tightening torque figures:

M5 lid fixings:	1N-m
M5 terminals:	2N-m
M6 terminals:	2.5N-m
M8 terminals:	5N-m
M10 terminals:	8N-m
M12 terminals:	11N-m
M16 terminals:	20N-m
M20 terminals:	32N-m

Safety

Relevant safety standards have been adhered to in the design and manufacture of these products. However, all capacitors will store charge after power has been removed and must be treated with respect as a shock can be lethal if the voltage and charge are high enough.

Even though discharge resistors are fitted to this range of filters, terminals should always be shorted to earth prior to touching to ensure the capacitors are fully discharged.

The user should ensure he is familiar with restrictions on capacitance value, earth leakage current, test voltage, and safety labelling requirements, which may be applicable to his particular installation.

These filters must be solidly and permanently earthed, both for safe operation and to achieve optimum EMC and pulse performance.

Custom Designs

MPE offers a rapid design service of custom designs satisfying customer requirements for special mounting, terminations or electrical ratings required. Over 50% of the filters manufactured by MPE are custom designs and this can offer a very cost effective installation solution. Please ask to see examples of previously offered solutions.