



MPE
Quality, Reliability, Performance

HIGH PERFORMANCE EQUIPMENT FILTERS

HIGH PERFORMANCE EQUIPMENT FILTERS

FOR GENERAL PURPOSE AND SWITCHED MODE POWER SUPPLY APPLICATIONS

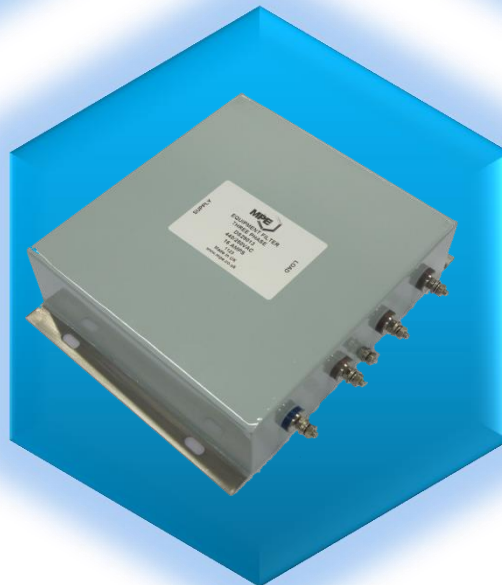
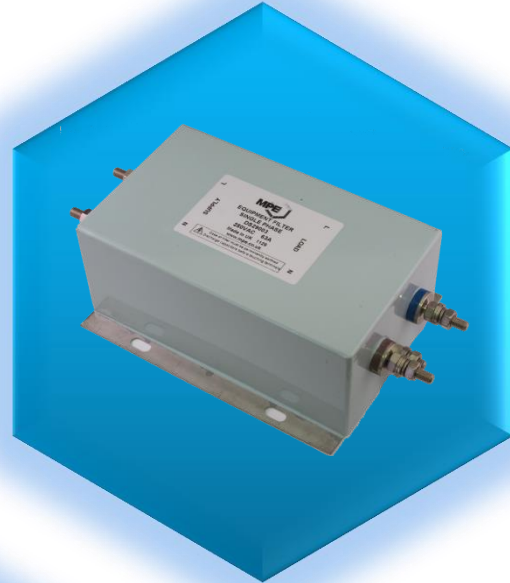
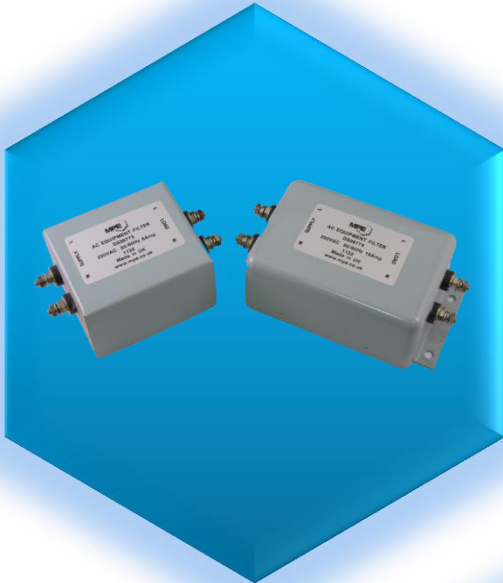

FM00699

MPE Limited
Hammond Road
Knowsley Industrial Park
Liverpool L33 7UL



HIGH PERFORMANCE EQUIPMENT FILTERS



General Purpose DC



General Purpose AC



SMPS



High Current 1 Phase



High Current 3 Phase

CONTENTS

Introduction

- General Purpose Filters Page 3
- Switched Mode Power Supply Filters Page 4

Selection Guide

Page 6

General Purpose Range

- DC 1A - 15A Page 7
- AC 1A - 15A Page 8
- Dimensions Page 10
- Installation Details Page 11

High Current Range

- AC Single Phase 30A -100A Page 12
- Dimensions Page 13
- AC Three Phase 30A -100A Page 14
- Dimensions Page 15

Switched Mode Power Supply Range

- AC 1A - 15A Page 9
- Dimensions Page 10
- Installation Details Page 11

Custom Designs

- Special mounting / packaging Page 16

Installation, Background, and Safety Information

Page 17

All filters in this catalogue are RoHS compliant



INTRODUCTION

High Performance Equipment Filters

These ranges of equipment filters are intended for general purpose applications where high performance over a wide range of frequencies is required. Separate ranges are offered for ac and dc applications, switched mode power supplies, and higher current requirements.

High performance is achieved through the use of MPE's proprietary feedthrough capacitors and bulkhead mounting design, which enable good filtering performance to be achieved to 1GHz and beyond. The feedthrough capacitors will also provide greater immunity of the equipment to high frequency transients than is usually provided by general purpose filters.

Most commercial equipment filters do not use feedthrough capacitors and are not designed for bulkhead mounting, which limits their useful performance above about 1MHz.

Above this frequency, the performance will drop off rapidly due to the capacitors going into self resonance. This can be a severe disadvantage as many EMC specifications now require equipment to be compliant to 1GHz and beyond, and filters not using feedthrough capacitors are unlikely to offer sufficient high frequency performance to achieve this.

The graphs below show the measured performance of two typical dc filter circuits. The circuits are identical apart from the fact that the one on the left uses feedthrough capacitors, so is representative of filters in this catalogue, and the other uses two-terminal capacitors of the same value, so is representative of many other general purpose commercial filters.

The graphs clearly show the dramatic difference in performance offered by the two circuits above 1MHz.

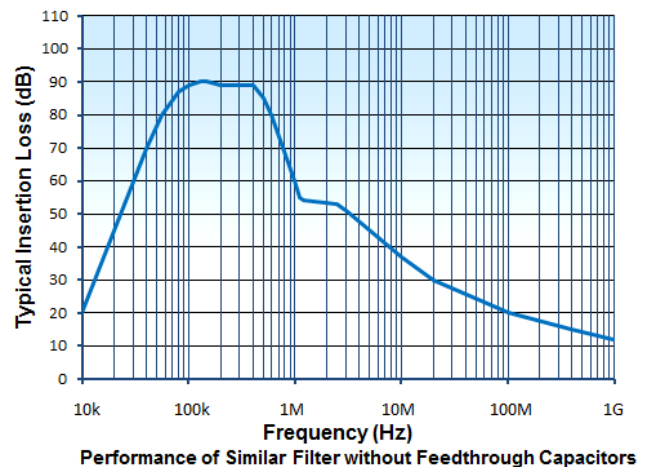
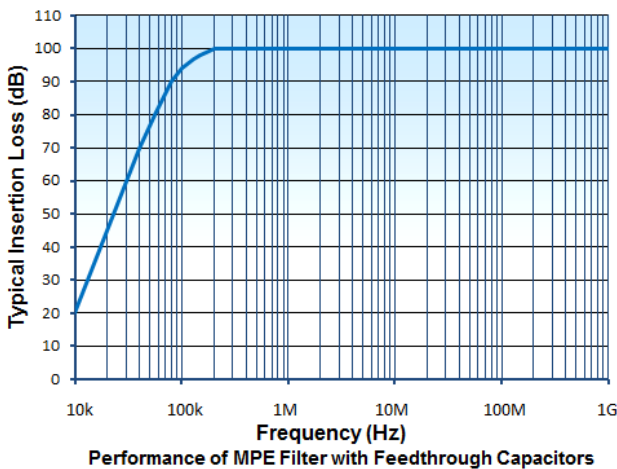

Summary of Features of MPE High Performance Equipment Filters

- * Excellent high frequency performance
- * Improves equipment immunity
- * Symmetric and asymmetric filtering modes
- * Full performance with / without load
- * High reliability design
- * Tested to 2250V proof voltages for safety (ac versions)
- * Low leakage current (ac versions on P8)



Switched Mode Power Supply Filters

Why are special filters needed for mains input for switched mode power supplies?

When considering published performance figures for filters, the insertion loss will invariably be quoted in a 50 ohm system. This is because, historically, 50 ohms was considered to be representative of most practical situations, and measurement specifications were written around this impedance.

In practice, many systems have an impedance different from 50 ohms. Switched mode power supplies are a common application requiring filtering where the impedance is not 50 ohms. In fact, a switched mode power supply (SMPS) will usually present a very low impedance to the filter.

For such applications, a filter performance measured in a 50 ohm system can be very misleading as it is unlikely to represent the attenuation which will be achieved when the filter is connected in circuit.

Many simple general purpose filter designs, although offering reasonable performance in a 50 ohm system, will offer little or no insertion loss when presented with a low impedance interference source such as a SMPS. A more specialised filter circuit therefore needs to be considered.

The problem arises due to the operating principles of the SMPS. The SMPS circuit will normally operate at a switching frequency of between 20kHz and 200kHz. This will generate unwanted RFI at the switching frequency and its numerous harmonics often up to several hundred MHz.

RFI noise is generated by the SMPS both in the asymmetric mode (each line to earth) and symmetric mode (live to neutral), the symmetric mode noise being predominant at the lower frequencies, up to a few hundred kHz, and the asymmetric mode noise being predominant at higher frequencies above about 1MHz.

Because the switching operation of the SMPS applies almost a short circuit across the line, the source impedance of the RFI generated by the SMPS is very low, typically 0.1 ohm, and this is the impedance presented to the filter. The other end of the filter will be facing the mains supply which is likely to have an impedance in the order of 50 - 100 ohms over the range of frequencies of interest.

In order to obtain good filter performance, it is necessary to achieve as great as possible an impedance mismatch between each end of the filter and the system in which it operates.

Part of the solution is to use a filter which has been specifically designed to operate in the practical system impedance. Such a filter design will have an inductive input to face the low impedance of the SMPS and a capacitive output to face the higher impedance of the mains supply.

A second requirement for a filter designed specially for use with switched mode power supplies is good symmetric mode performance which must, of course, be provided in the practical system impedance.

Finally, if the noise generated by the SMPS extends into frequencies beyond a few MHz, then the two-terminal capacitors normally used in most types of commercial general purpose filters will probably not be adequate as they will go into resonance and lose performance above a few MHz. For EMC specifications which specify noise levels up to 30MHz, this can be a problem, especially if the SMPS is particularly noisy.

A filter design incorporating feedthrough capacitors then needs to be used. This is even more important if the specification requirement extends beyond 30MHz which is the increasing tendency. The filters should be bulkhead mounted to ensure maximum filter performance is obtained.



MPE mains input filters for switched mode power supplies

Based on experience gained from testing and providing filtering solutions for numerous types of switched mode power supplies over a number of years, MPE has developed a range of mains input equipment filters specifically for switched mode power supplies.

These filters feature all of the benefits of the general purpose filters described on previous pages but also incorporate the circuitry required to provide effective suppression under the special impedance conditions presented by the switched mode power supply for both modes of interference.

The standard range of filters detailed on the following pages has a mains input rating of 240V 50/60Hz with current ratings of 1, 3, 6, 10, and 15 amps.

Insertion loss performance is quoted both in the usual 50 ohm system and also in a 0.1/100 ohm system to provide a more realistic indication of the likely performance which will be achieved with the filter connected in circuit. The 0.1/100 ohm test is derived from BS EN 55017:2011 as a worst case test method for power line filters, but is equally appropriate for SMPS filters.

High quality feedthrough capacitors are used in the filters which are designed for bulkhead mounting to permit high filtering performance to be achieved up to frequencies of 1GHz and beyond.

The filters will also provide improved immunity of the switched mode power supply against mains borne interference, and have low leakage current for where there may be capacitance limitations for use on portable equipment.

The bulkhead mounting design of the filters facilitates interfacing with shielding of the switched mode power supply to help prevent radiated interference.

These filters are also suitable for other applications which may have a low source or load impedance. To offer the best performance, the filters should be connected so that their inductive end faces the lower impedance. (N.B. The inductive end of the filter is marked "To SMPS")

It should be remembered that these filters have been designed to operate with a low source impedance. They will offer the performance quoted where the practical impedance is the same as the measurement system impedance.

Because no two SMPS circuits will have the same characteristics in terms of impedance and noise emissions, any filter must be expected to perform differently in different applications. Some applications may therefore require custom designed filter solutions to provide full specification compliance - see page 16 for more details.

MPE also design and manufacture other components suitable for use with switched mode power supplies. These include general purpose capacitors and suppression components, output filters, and high performance, low ESR capacitors.

Summary of Features of MPE Filters for Switched Mode Power Supplies

- * Prevents SMPS generated noise from contaminating mains supply
- * Excellent performance under SMPS low impedance conditions
- * Improves immunity of SMPS against mains-borne interference
- * Excellent high frequency performance
- * Symmetric and asymmetric filtering modes
- * Application tested design
- * Proof test voltage of 2250V dc
- * Low leakage current



SELECTION GUIDE

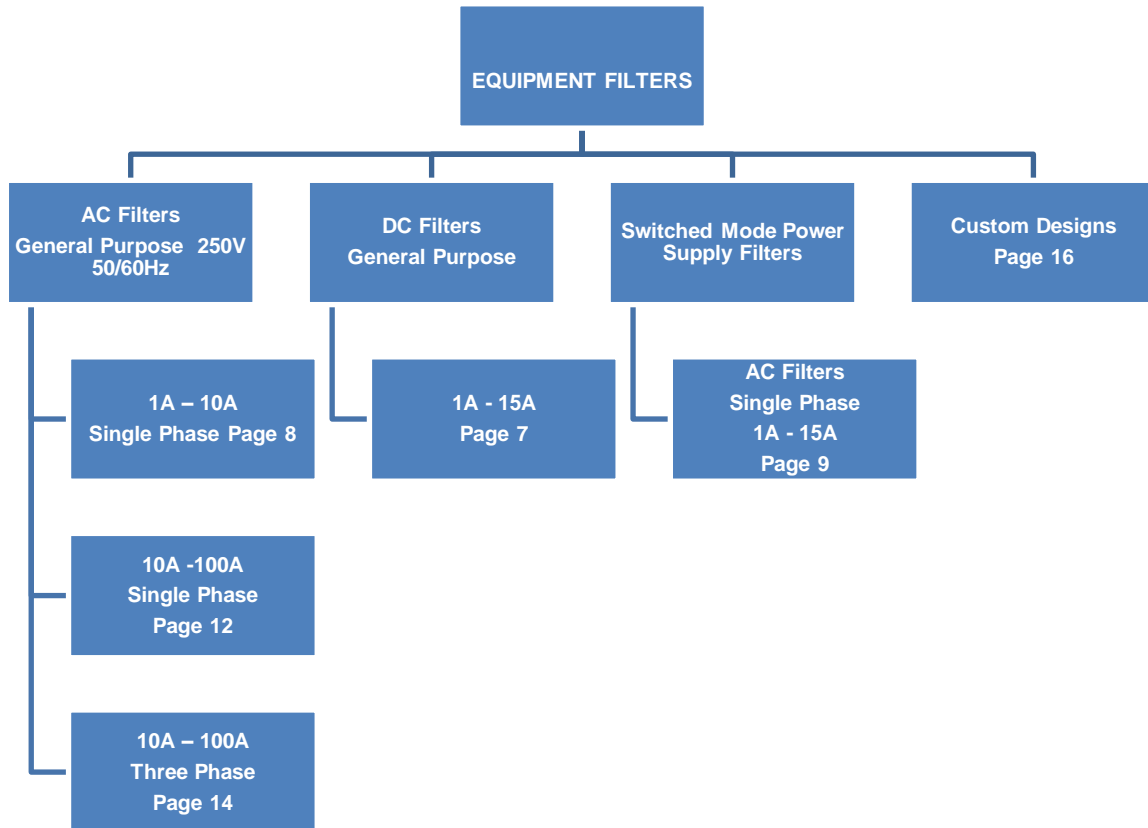

All AC Filters are also suitable for use on DC
– See specification pages for appropriate DC rating



DESCRIPTION

A range of high performance dc power input filters for filtering incoming power to sensitive or noisy equipment.

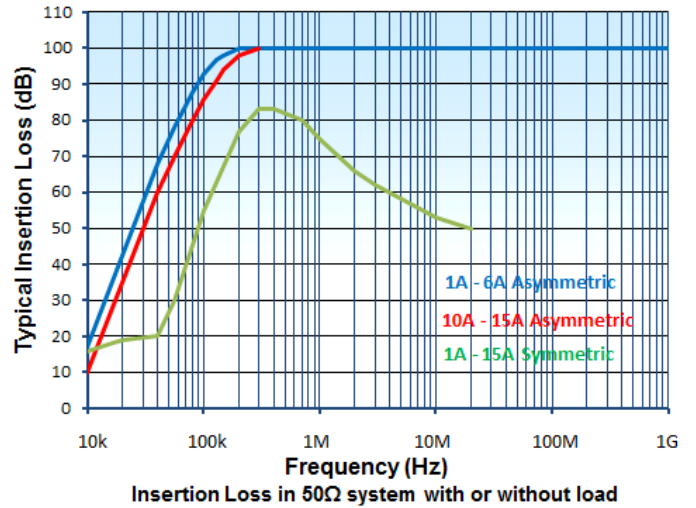

RATINGS AND CHARACTERISTICS

Rated Voltage	100V dc
Test Voltage	200V dc
Rated Current, I _R	As tabulated
Insertion Loss	See graph
Maximum Volt Drop per line at full load dc current	250mV
Maximum Full Load Heat Dissipation	As tabulated
Maximum Temperature Rise at Full Load	25°C
Ambient Temperature Range	-40°C to +85°C
Climatic Category	40/85/21

PRODUCT RANGE

Part Number	Current Rating @ 50°C I _R (A) *	Maximum Heat Dissipation (W)	Major Dimensions (mm)			Weight (g)
			Length A	Width B	Depth C	
DS26780	1	0.15	51	51	32	170
DS26781	3	1.5	51	51	32	170
DS26782	6	3.5	64	56	38	260
DS26783	10	2.0	88	60	38	440
DS26784	15	4.5	88	60	38	440

* Current derating between 50°C and 85°C

For temperature, θ $I_{\theta} = I_R \sqrt{(85 - \theta) / 35}$

See page 10 for full dimensions
See page 11 for installation details



DESCRIPTION

A range of high performance ac mains input filters for filtering incoming power to sensitive or noisy equipment.

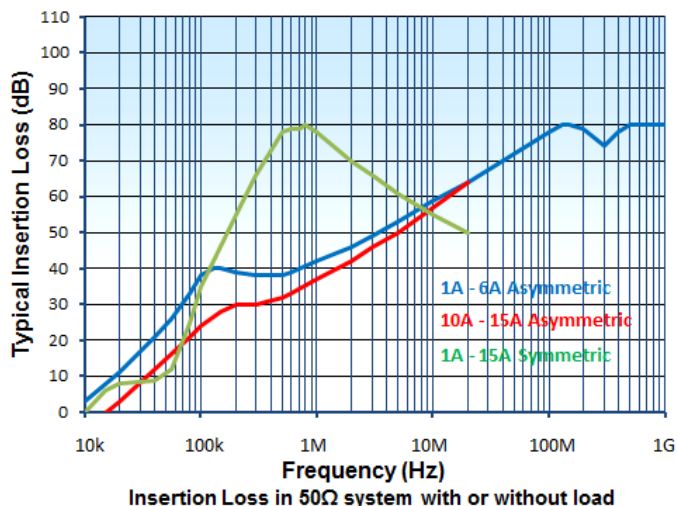

RATINGS AND CHARACTERISTICS

Rated Voltage	250V ac 50/60Hz, 250Vdc
Test Voltage (line – earth)	2250V dc
(line – line)	1250V dc
Rated Current, I _R	As tabulated
Insertion Loss	See graph
Maximum Volt Drop per line at full load dc current	250mV
Maximum Full Load Heat Dissipation	As tabulated
Discharge Time to below 34V	2s maximum
Maximum Temperature Rise at Full Load	25°C
Ambient Temperature Range	-40°C to +85°C
Climatic Category	40/85/21
Maximum Leakage Current (at 250V 50Hz)	0.4mA

PRODUCT RANGE

Part Number	Current Rating @ 50°C I _R (A) *	Maximum Heat Dissipation (W)	Major Dimensions (mm)			Weight (g)
			Length A	Width B	Depth C	
DS26770	1	0.15	51	51	32	170
DS26771	3	1.5	51	51	32	170
DS26772	6	3.5	64	56	38	260
DS26773	10	2.0	88	60	38	440
DS26774	15	4.5	88	60	38	440

* Current derating between 50°C and 85°C For temperature, θ $I_{\theta} = I_R \sqrt{(85 - \theta)/35}$

See page 10 for full dimensions
See page 11 for installation details



DESCRIPTION

A range of mains input filters for switched mode power supplies to prevent smps generated noise from getting back onto the mains.

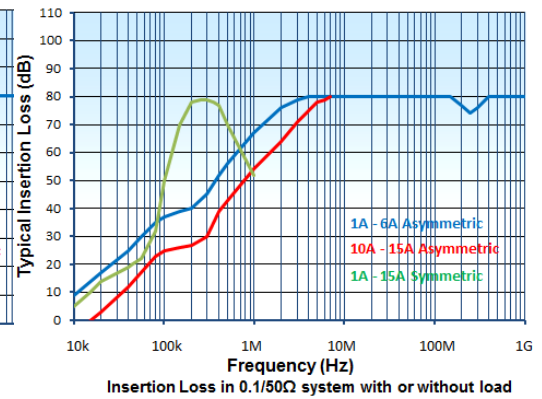
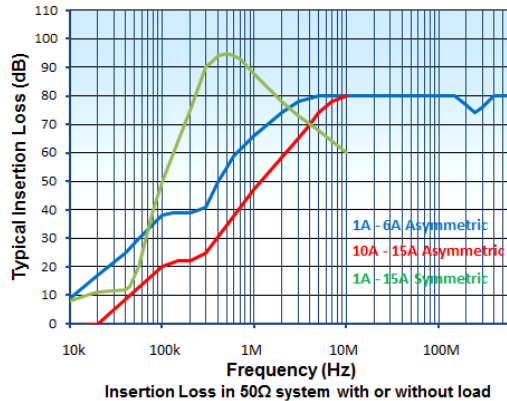

RATINGS AND CHARACTERISTICS

Rated Voltage	250V ac 50/60Hz, 250Vdc
Test Voltage (line – earth)	2250V dc
(line – line)	1250V dc
Rated Current, I _R	As tabulated
Insertion Loss	See graphs
Maximum Volt Drop per line at full load dc current	300mV
Maximum Full Load Heat Dissipation	As tabulated
Discharge Time to below 34V	2s maximum
Maximum Temperature Rise on Full Load	25°C
Ambient Temperature Range	-40°C to +85°C
Climatic Category	40/85/21
Maximum Leakage Current (at 250V 50Hz)	0.4mA

PRODUCT RANGE

Part Number	Current Rating @ 50°C I _R (A) *	Maximum Heat Dissipation (W)	Major Dimensions (mm)			Weight (g)
			Length A	Width B	Depth C	
DS26760	1	0.3	64	56	38	275
DS26761	3	2.5	64	56	38	275
DS26762	6	3.5	88	60	38	455
DS26763	10	3.0	112	76	38	750
DS26764	15	6.5	112	76	38	750

* Current derating between 50°C and 85°C

For temperature, θ $I_{\theta} = I_R \sqrt{(85 - \theta) / 35}$

See page 10 for full dimensions
See page 11 for installation details



DIMENSIONS AND MECHANICAL DETAILS

Dimensions in mm

Case Electroplated steel, painted
Terminals Nickel plated brass

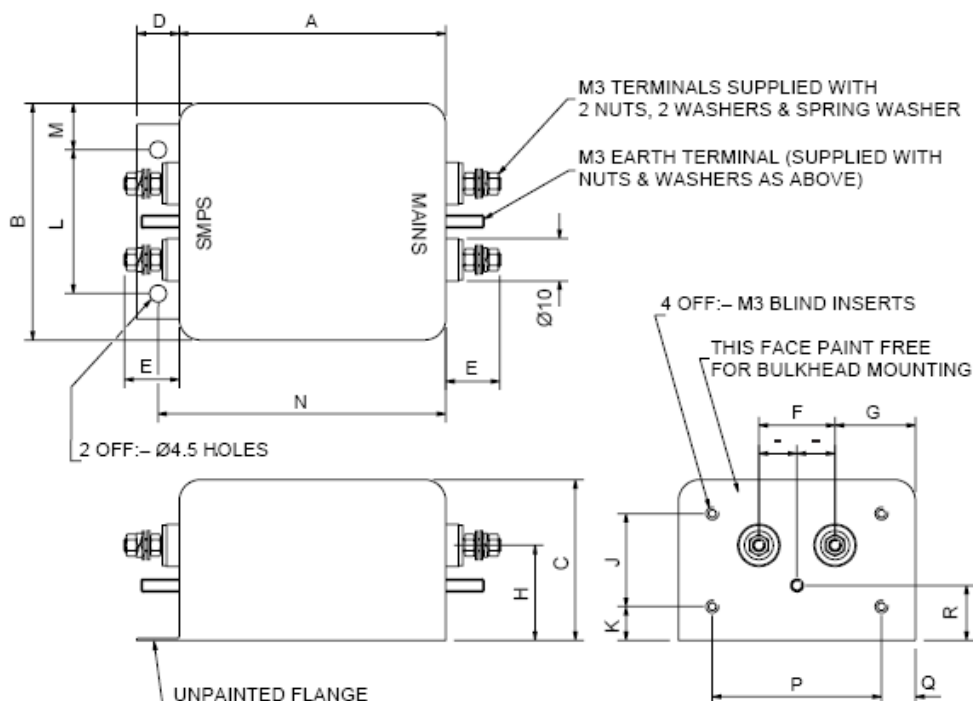

Note Mains input is normally on bulkhead mounting side of filter
Terminal orientation marking shown relates to SMPS range
For SMPS filters, correct orientation is important for optimum filter performance
For general purpose ac and dc ranges, filters may be used either way round without loss in performance.
See installation details on page 11 for more details.

Part Number	Dimensions (mm)															
	A	B	C	D	E	F	G	H	J	K	L	M	N	P	Q	R
DS26780, DS26781 DS26770, DS26771	51	51	32	-	13	16	17.5	21.5	18	7	-	-	-	37	7	10.5
DS26782, DS26772 DS26760, DS26761	64	56	38	-	13	18	19	25	22	7	-	-	-	40	8	12.5
DS26783, DS26784 DS26773, DS26774 DS26762	88	60	38	11	13	20	20	25	20	9	35	12.5	94	44	8	12.5
DS26763, DS26764	112	76	38	11	13	25	25.5	25	17	9	51	12.5	118	56	10	12.5



INSTALLATION

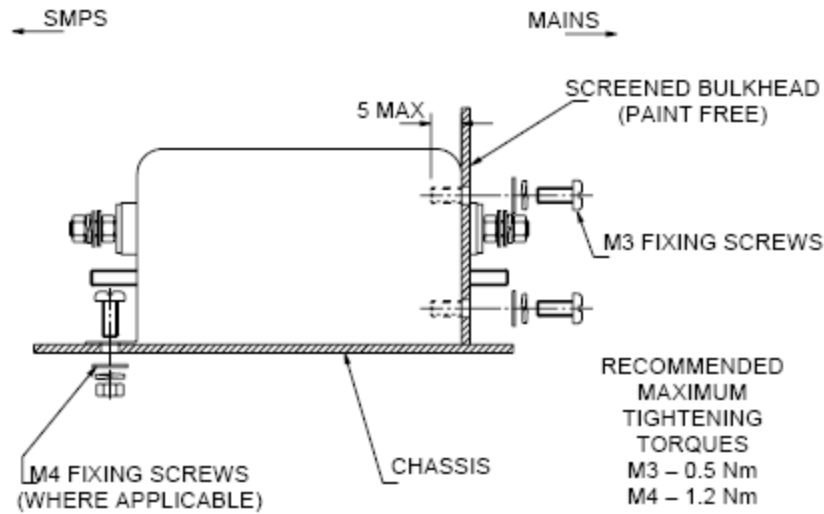

Typical installation details are shown above.

These filters should ideally be mounted through a conductive metal bulkhead (unpainted but electroplated to prevent corrosion, if applicable). They should be fixed using 4 M3 screws of an appropriate length to suit the bulkhead thickness. This method of mounting will provide optimum high frequency filter performance. Larger filters are also provided with a mounting flange at the other end of the filter which should be secured with M4 screws. It is important that a good low impedance earth connection is obtained between the end of the filter and the bulkhead.

If bulkhead mounting is not used, the filter may be mounted using suitable brackets from the filter inserts, again ensuring that a good earth connection is made to the filter either via the mounting bracket or via the earth stud connection. Without bulkhead mounting, to maintain the high frequency performance of the filter, it is important to minimise by-pass coupling of the filter by using screened leads and by careful consideration of cable routing.

Bulkhead mounting is recommended to ensure the best high frequency performance is obtained. The quoted torque figures should be observed for the mounting inserts and the filter terminals. When making connections to the filter terminals, two spanners should be used to avoid applying excessive torque to the filter terminal studs.

In the case of SMPS filters, the end marked "SMPS" is the inductive end of the filter and should face the SMPS or low impedance. The other end marked "MAINS" (bulkhead mounting end) should face the higher impedance, (normally the mains). General purpose filters may be connected either way round.

It must always be ensured that a good low impedance earth connection is made to the filter

Terminals should be enclosed by the user, if required, for safety.

SAFETY

All high performance filters contain capacitors which will store charge even after the power has been removed from the filter. All ac filters listed in this catalogue are fitted with internal discharge resistor networks. These are intended to discharge the capacitors to a safe level within two seconds of switching off the power.

As an added precaution, after removing the power, filter terminals should always be shorted to earth (filter case) and to each other, before touching. A good low impedance earth connection must be made to the filter.



DESCRIPTION

This range of high current equipment filters is suitable for a wide variety of EMC applications where high performance filtering of single phase ac mains lines is required. The filters incorporate feedthrough capacitors to give excellent high frequency performance. They are designed for either bulkhead or chassis mounting for optimum flexibility although maximum performance will only be achieved when bulkhead mounted. Self-healing metallised plastic film capacitors are used for maximum reliability and safety. This range of filters is intended for use in a permanently earthed application and complies with the proof voltage requirements of BS EN60939—2: 2005.

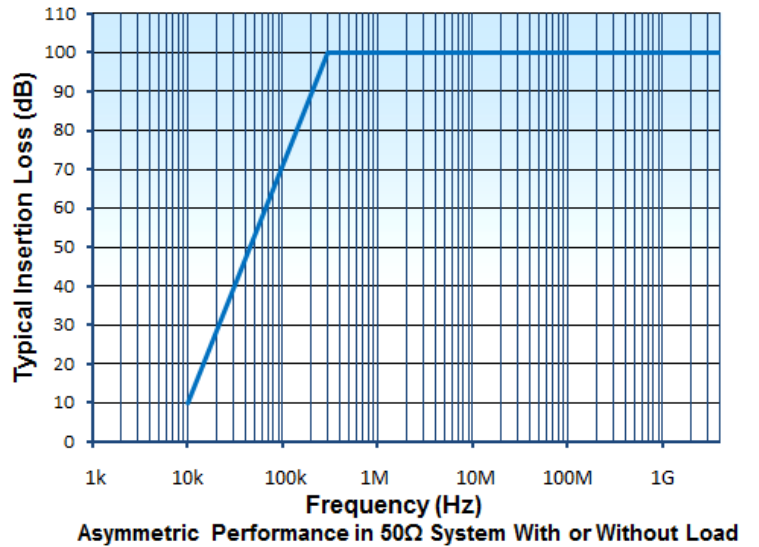

RATINGS AND CHARACTERISTICS

Rated Voltage	250V ac 50/60Hz, 250V dc
Test Voltage (line – earth)	2250V dc
Test Voltage (line – line)	1250V dc
Rated Current, I _R	As tabulated
Maximum Temperature Rise on Full Load	25°C
Operating Temperature Range	-40°C to +85°C
Climatic Category	40/85/21
Maximum Leakage Current (at 250V 50Hz)	125mA
Maximum Heat Dissipation	As tabulated
Insertion Loss (50Ω, asymmetric)	100dB from 300kHz to 1GHz (see graph)
Maximum Discharge Time to below 34V	2 seconds

PRODUCT RANGE

Part Number	Current Rating @ 50°C I _R (A) *	Maximum Heat Dissipation (W)	Major Dimensions (mm)			Weight (kg)
			Length A	Width B	Depth C	
DS29000	10	2	105	85	50	0.75
DS29001	16	3	105	85	50	0.75
DS29002	32	5	130	85	50	1
DS29003	63	11	170	100	70	2
DS29004	100	24	220	110	85	2.5

* Current derating between 50°C and 85°C For temperature, θ $I_b = I_R \sqrt{(85 - \theta)/35}$



DIMENSIONS AND MECHANICAL DETAILS

Dimensions in mm

Case Electroplated steel, painted
Terminals Nickel plated brass

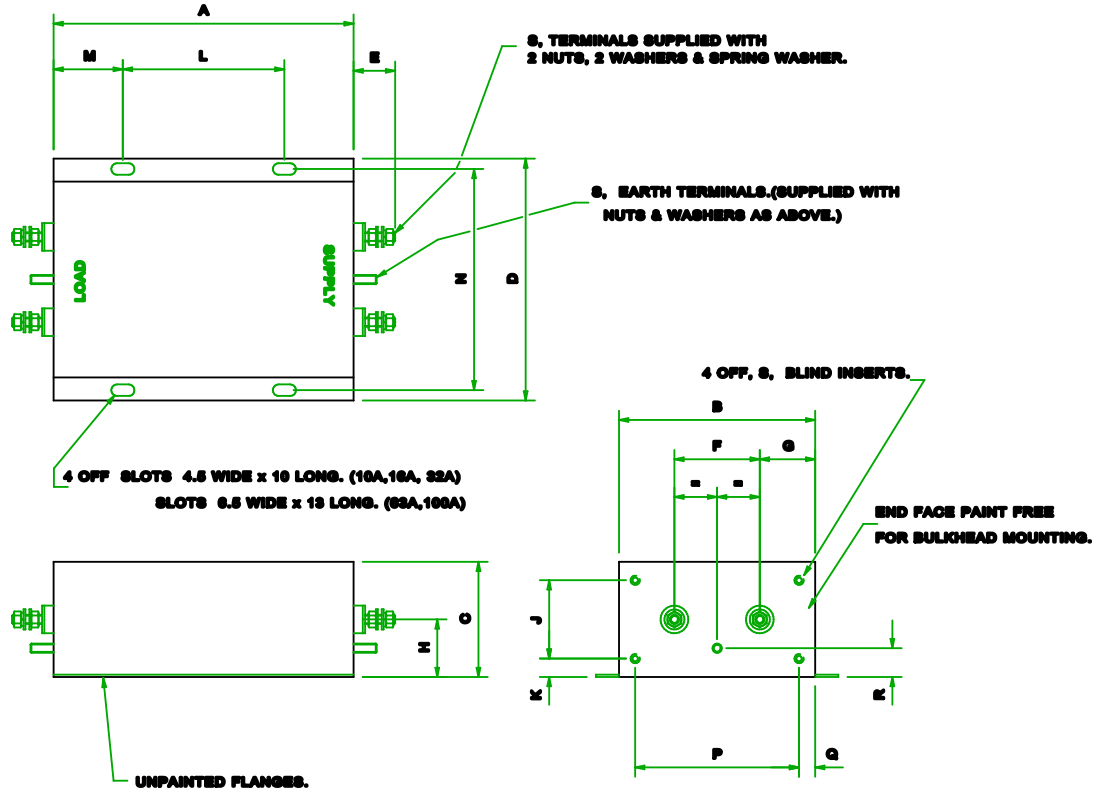

Part Number	Dimensions (mm)																
	A	B	C	D	E	F	G	H	J	K	L	M	N	P	Q	R	S
DS29000	105	85	50	105	18	37	24	25	34	8	55	25	96	71	7	12.5	M4
DS29001	105	85	50	105	18	37	24	25	34	8	55	25	96	71	7	12.5	M4
DS29002	130	85	50	105	18	37	24	25	34	8	70	30	96	71	7	12.5	M4
DS29003	170	100	70	128	32	40	30	40	50	10	90	40	114	76	12	20	M6
DS29004	220	110	85	138	32	45	32.5	50	65	10	120	50	124	86	12	25	M6

INSTALLATION DETAILS

The chassis and/or bulkhead should be a flat clean paint-free metal surface to provide a good low impedance earth bond.

Recommended thread tightening torques: M4: 1.2 N-m M6: 2.5 N-m

SAFETY

These filters must be solidly and permanently earthed via the chassis mounting, the bulkhead mounting, or via the earth screw provided. Terminals must be suitably enclosed by the user.

These filters are fitted with discharge resistors, but the user must still ensure that the capacitors are safely discharged prior to touching terminals.



DESCRIPTION

This range of high current equipment filters is suitable for a wide variety of EMC applications where high performance filtering of single phase ac mains lines is required. The filters incorporate feedthrough capacitors to give excellent high frequency performance. They are designed for either bulkhead or chassis mounting for optimum flexibility although maximum performance will only be achieved when bulkhead mounted. Self-healing metallised plastic film capacitors are used for maximum reliability and safety. This range of filters is intended for use in a permanently earthed application and complies with the proof voltage requirements of BS EN60939-2:2005.

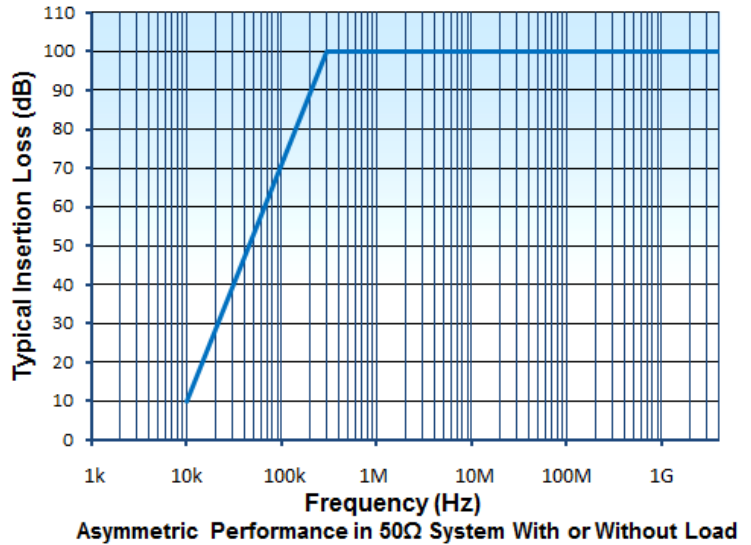

RATINGS AND CHARACTERISTICS

Rated Voltage	440/250V ac 50/60Hz
Test Voltage (line – earth)	2250V dc
Test Voltage (line – line)	1250V dc
Rated Current, I _R	As tabulated
Maximum Temperature Rise on Full Load	25°C
Operating Temperature Range	-40°C to +85°C
Climatic Category	40/85/21
Maximum Leakage Current (at 250V 50Hz)	125mA
Maximum Heat Dissipation	As tabulated
Insertion Loss (50Ω, asymmetric)	100dB from 300kHz to 1GHz (see graph)
Maximum Discharge Time to below 34V	2 seconds

PRODUCT RANGE

Part Number	Current Rating @ 50°C I _R (A) *	Maximum Heat Dissipation (W)	Major Dimensions (mm)			Weight (kg)
			Length A	Width B	Depth C	
DS29012	10	7	170	180	50	2
DS29013	16	11	170	180	50	2
DS29014	32	20	170	180	75	3
DS29015	63	40	220	180	85	5
DS29016	100	60	300	180	90	7

* Current derating between 50°C and 85°C

For temperature, θ $I_{\theta} = I_R \sqrt{(85 - \theta)/35}$



DIMENSIONS AND MECHANICAL DETAILS

Dimensions in mm

Case Electroplated steel, painted
Terminals Nickel plated brass

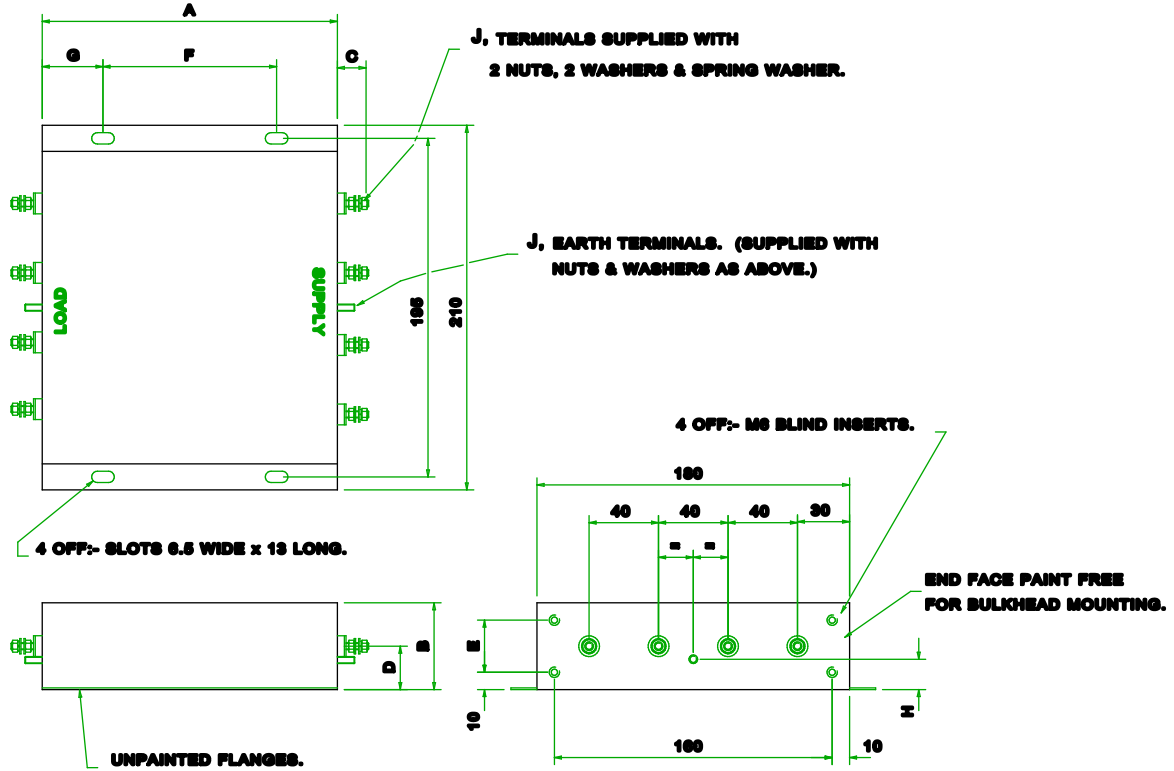

Part Number	Dimensions (mm)									
	A	B	C	D	E	F	G	H	J	
DS29012	170	50	18	25	30	100	35	17.5	M4	
DS29013	170	50	18	25	30	100	35	17.5	M4	
DS29014	170	75	18	37.5	55	100	35	25	M4	
DS29015	220	85	32	42.5	65	120	50	25	M6	
DS29016	300	90	32	45	70	200	50	25	M6	

INSTALLATION DETAILS

The chassis and/or bulkhead should be a flat clean paint-free metal surface to provide a good low impedance earth bond.

Recommended thread tightening torques: M4: 1.2 N-m M6: 2.5 N-m

SAFETY

These filters must be solidly and permanently earthed via the chassis mounting, the bulkhead mounting, or via the earth screw provided. Terminals must be suitably enclosed by the user.

These filters are fitted with discharge resistors, but the user must still ensure that the capacitors are safely discharged prior to touching terminals.



CUSTOM DESIGN EXAMPLES

Special Features

Cost effective packaging



Easy installation

Special interfaces



Multiple lines

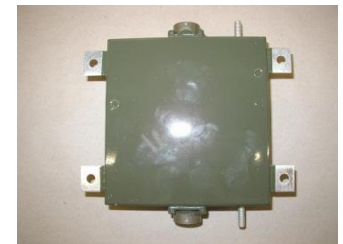

Cable terminations



Connector interfaces



Cable lug terminations



Screened leads



High reliability

Extreme shock/ vibration
(eg up to 40g)

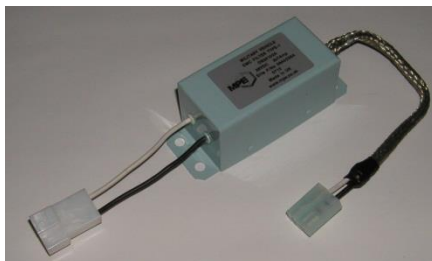

Custom paint finishes





INSTALLATION GUIDELINES

Equipment filters are designed for bulkhead mounting to offer high performance, high frequency filtering. The bulkhead mounting surface should be clean and unpainted to offer a low impedance path from the filter to the equipment chassis. Poor earth bonding will limit the available performance of the product and could compromise safety.

Conductive paint finishes should be avoided as they do not usually provide adequate conductivity.

2 spanners should be used when making electrical connections to the terminals, and maximum tightening torque figures quoted should be observed.

CONSTRUCTION AND RELIABILITY

MPE have been designing and manufacturing feedthrough capacitors and filters for more than 40 years. MPE has always been at the forefront of the design of feedthrough capacitors and the improvements in materials and assembly techniques, which have evolved over the years, have been incorporated into these products. All key components including capacitors and inductors are made in-house ensure maximum control over the manufacturing processes. The designs covered by this catalogue all utilise self-healing metallised plastic film capacitor material and incorporate a solderless capacitor assembly technique to avoid heat damage to the plastic dielectric material, which would reduce its life and reliability. Terminals are nickel plated for good conductivity.

FEEDTHROUGH CAPACITOR PERFORMANCE

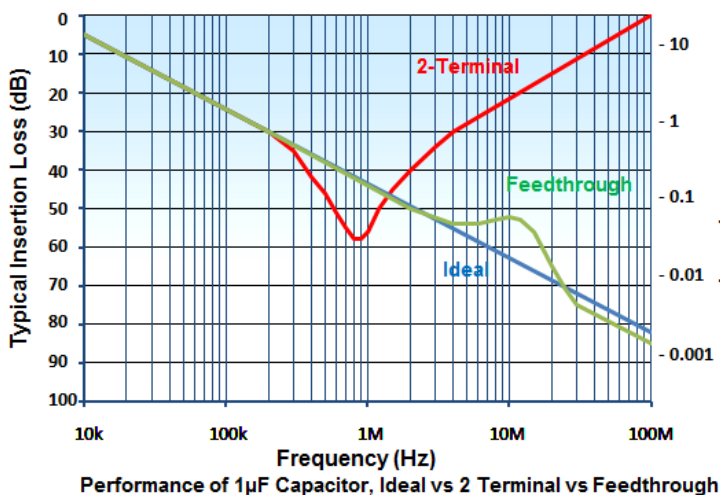

- Normal two-terminal capacitors resonate with their lead inductance in the region 1-10MHz
- This limits their use as suppression components above a few MHz
- Feedthrough capacitors have no major resonance as they have no lead inductance
- Their performance continues to increase with frequency
- Hence feedthrough capacitors are essential for good high frequency performance
- As an example this graph compares the performance of a 1µF feedthrough capacitor with a 1µF two-terminal capacitor
- Feedthrough filters incorporate feedthrough capacitors for the same benefits

SAFETY

Relevant safety standards have been adhered to in the design and manufacture of these products. However, all capacitors will store charge after power has been removed and must be treated with respect as this can be lethal when the voltage and charge are high enough. The ac filters covered by this catalogue contain internal discharge resistors to discharge their capacitors after the power has been removed. Where necessary, terminals should be enclosed by the user to prevent any danger of electric shock or accidental shorting.

In all cases, filters should always be shorted to earth prior to touching to ensure they are fully discharged.

The user should ensure he is familiar with restrictions on capacitance value, earth leakage current, test voltage, and safety labelling requirements, which may be applicable to his particular installation.

CUSTOM DESIGNS

MPE offers a rapid design service for custom designs where special packaging, mounting, terminations, or multiple lines are required. Over 50% of the feedthrough components manufactured by MPE are custom designs and this can offer a very cost effective installation solution. See page 16 for examples of previously offered solutions.

FURTHER INFORMATION

For more detailed technical background information, and application notes detailing the benefits of feedthrough capacitors over traditional capacitors, please contact the factory.