

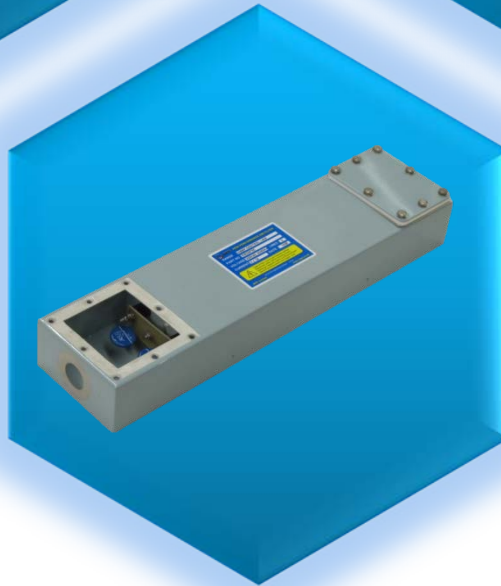

MPE
Quality, Reliability, Performance

HEMP PROTECTION FILTERS

HEMP & IEMI PROTECTION FILTERS FOR CONTROL LINES

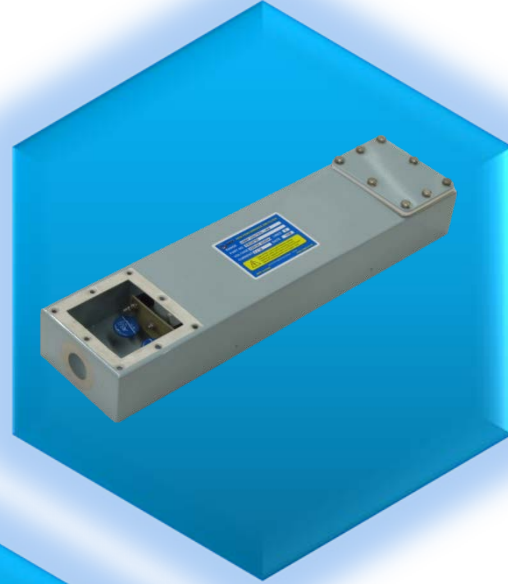
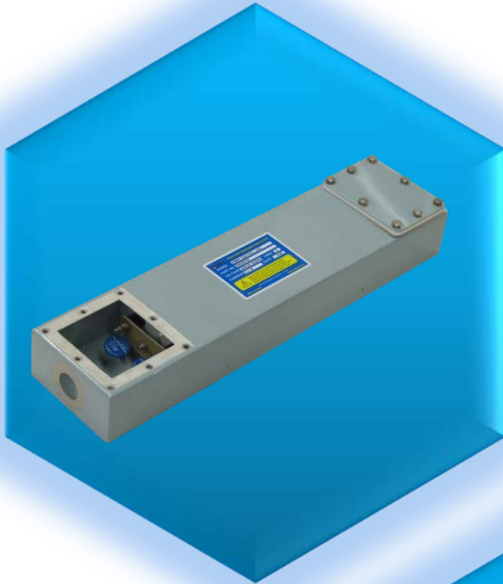

Mil-Std-188-125
Mil-F-15733
Mil-Std-220C
CISPR17:2011/BS EN 55017:2011
UL1283
EN60950/IEC60950/UL60950
USACE 13.27.54.01
UFGS 13.49.20.01

All MPE HEMP filters are tested using the test methods defined within the above standards and meet or exceed the relevant performance and/or safety criteria defined within these standards

Multi-Line HEMP Control Line Filters 28VDC, 48VDC, 120VAC, 250VAC 1A Meeting Requirements of MIL-STD-188-125-1 & -2



FM00699

MPE Limited
Hammond Road
Knowsley Industrial Park
Liverpool L33 7UL
UK



HEMP Protected Control Line Filter Range

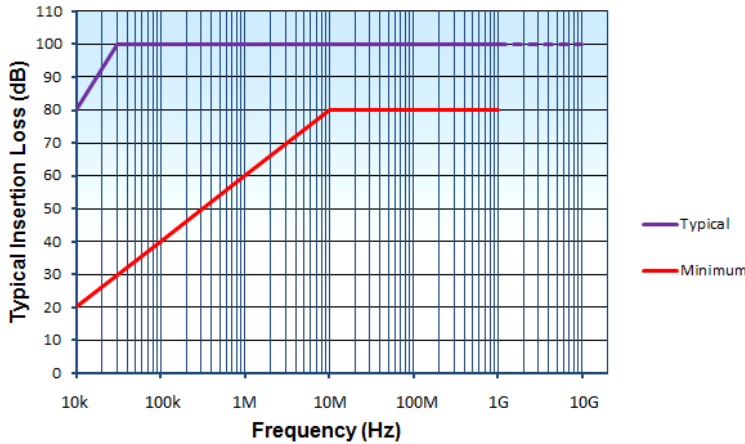

Asymmetric Performance in 50Ω System With or Without Load



Description

Ranges of multi-line HEMP protection filters for control lines suitable for use in various HEMP protected installations. All lines are individually filtered and feature inductive input to offer both good continuous wave EMC performance and superior transient handling performance. All lines feature high-energy varistor transient suppressors at the input end. Two ac ranges of filters are offered rated at 250VAC and 120VAC meeting the pci requirements of MIL-STD -188-125-1 & -2 for high voltage control lines working at >90V. Two dc ranges rated at 28VDC and 48VDC, meet the pci requirements of MIL-STD -188-125-1 & -2 for low voltage control lines working at <90V

Features

- Ranges for high and low voltage control lines (250VAC & 120VAC, 48VDC & 28VDC)
- 1A to 5A current ratings
- 2, 4, and 8 line versions
- RoHS compliant

Ratings and Characteristics

	28VDC Range	48VDC Range	120VAC Range	250VAC Range
Rated Voltage	28VDC	48VDC	120VAC 50/60Hz	250VAC 50/60Hz
Rated Current	1A to 5A	1A to 5A	1A to 5A	1A to 5A
Test Voltage (each line to case)*	300VDC	300VDC	2250VDC	2250VDC
Insulation Resistance*	>100MΩ	>100MΩ	>100MΩ	>100MΩ
Discharge Resistors (each line – case)	560kΩ	560kΩ	560kΩ	560kΩ
Discharge Time to Below 34V	N/A	N/A	<10s	<10s
Varistor Voltage Rating	38VDC	65VDC	150VAC	275VAC
Varistor Peak Surge Current	2kA (8/20μs)	6.5kA (8/20μs)	8kA (8/20μs)	8kA (8/20μs)

* test voltage and insulation resistance prior to fitting transient suppressors and discharge resistors

Maximum Volt Drop at Rated Current	See tables
Operating Temperature Range	-40°C to +85°C
Full Load Temperature Range	-40°C to +50°C
Full Load Heat Dissipation	See tables
Maximum Temperature Rise on Full Load	25 °C
Insertion Loss	See graph



Transient Suppression Performance

MIL STD 188-125-1 acceptance test, E1 short pulse current injection, wave shape 20/500ns					
Input pulse amplitude	250A	500A	1000A	1800A	2500A
AC RANGES					
MIL-STD-188-125 residual requirement (120VAC Range & 250VAC Range)	<1A	<1A	<1A	<1A	<1A
Typical filter residual let-through (120VAC Range)	<0.4A	<0.4A	<0.4A	<0.4A	<0.4A
Typical filter residual let-through (250VAC Range)	<0.4A	<0.4A	<0.4A	<0.4A	<0.4A
DC RANGES					
MIL-STD-188-125 residual requirement (28VDC Range & 48VDC Range)	<100mA	<100mA	<100mA	<100mA	<100mA
Typical filter residual let-through (28V Range)	<50mA	<50mA	<50mA	<50mA	<50mA
Typical filter residual let-through (48V Range)	<80mA	<80mA	<80mA	<80mA	<80mA

MIL STD 188-125-1 acceptance test, E2 intermediate pulse current injection, wave shape 1.5/3000µs	
Input pulse amplitude	No requirement for Control Lines

Product Range (DC RANGES)

Part Number	Voltage Rating VDC	Current Rating (A) @50°C	No of Lines	DC Volt Drop per line (V)	Full Load Heat Dissipation per line (W)	Major Dimensions (see page 4 for full dimensions)			Weight (kg)
						Length	Width	Depth	
DS33590	28	1	2	2.7	2.7	410	90	45	2.5
DS33591	28	1	4	2.7	2.7	410	175	45	5
DS33592	28	1	8	2.7	2.7	410	340	45	10
DS33593	28	2	2	1.3	2.6	410	90	45	2.5
DS33594	28	2	4	1.3	2.6	410	175	45	5
DS33595	28	2	8	1.3	2.6	410	340	45	10
DS33596	28	5	2	0.8	5	410	90	45	2.5
DS33597	28	5	4	0.8	5	410	175	45	5
DS33598	28	5	8	0.8	5	410	340	45	10
DS33800	48	1	2	2.7	2.7	410	90	45	2.5
DS33801	48	1	4	2.7	2.7	410	175	45	5
DS33802	48	1	8	2.7	2.7	410	340	45	10
DS33803	48	2	2	1.3	2.6	410	90	45	2.5
DS33804	48	2	4	1.3	2.6	410	175	45	5
DS33805	48	2	8	1.3	2.6	410	340	45	10
DS33806	48	5	2	0.8	5	410	90	45	2.5
DS33807	48	5	4	0.8	5	410	175	45	5
DS33808	48	5	8	0.8	5	410	340	45	10



Product Range (AC RANGES)

Part Number	Voltage Rating VAC (50/60Hz)	Current Rating (A) @50°C	No of Lines	DC Volt Drop per line (V)	Full Load Heat Dissipation per line (W)	Major Dimensions (see page 4 for full dimensions)			Weight (kg)
						Length	Width	Depth	
DS33690	120	1	2	2.7	2.7	410	90	45	2.5
DS33691	120	1	4	2.7	2.7	410	175	45	5
DS33692	120	1	8	2.7	2.7	410	340	45	10
DS33693	120	2	2	1.3	2.6	410	90	45	2.5
DS33694	120	2	4	1.3	2.6	410	175	45	5
DS33695	120	2	8	1.3	2.6	410	340	45	10
DS33696	120	5	2	0.8	5	410	90	45	2.5
DS33697	120	5	4	0.8	5	410	175	45	5
DS33698	120	5	8	0.8	5	410	340	45	10
DS33670	250	1	2	2.7	2.7	410	90	45	2.5
DS33671	250	1	4	2.7	2.7	410	175	45	5
DS33672	250	1	8	2.7	2.7	410	340	45	10
DS33673	250	2	2	1.3	2.6	410	90	45	2.5
DS33674	250	2	4	1.3	2.6	410	175	45	5
DS33675	250	2	8	1.3	2.6	410	340	45	10
DS33676	250	5	2	0.8	5	410	90	45	2.5
DS33677	250	5	4	0.8	5	410	175	45	5
DS33678	250	5	8	0.8	5	410	340	45	10



Dimensions and Mechanical Details

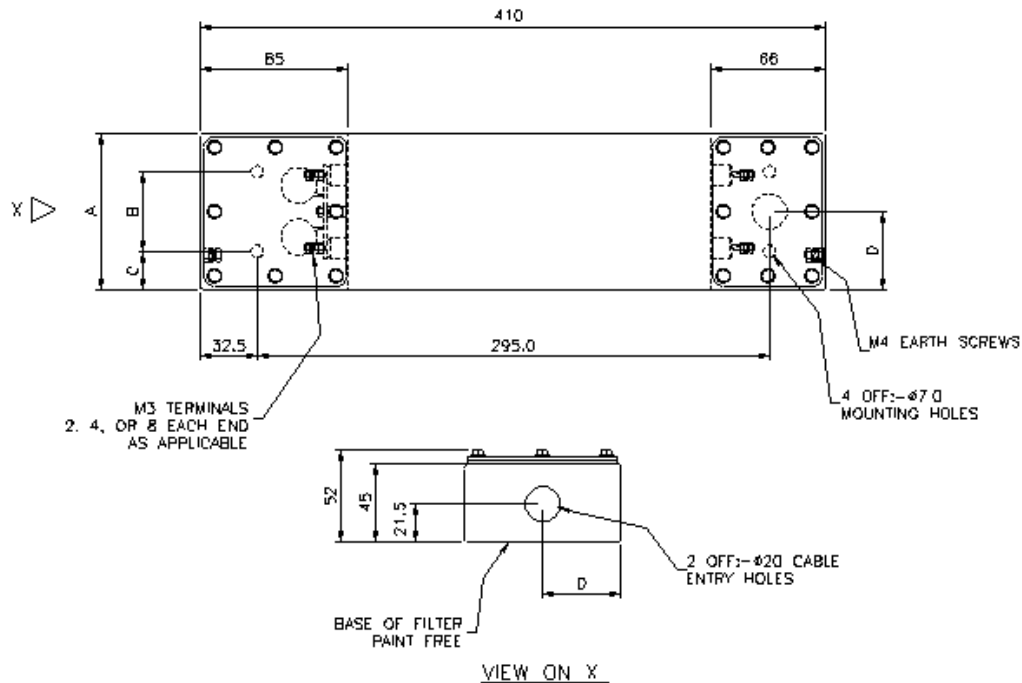

No of Lines	Dimensions (mm)			
	A	B	C	D
2	410	46	22	45
4	410	100	37.5	87.5
8	410	250	45	170

Case material
Finish
Terminals
Cable entry options
Fixing kit

Electroplated steel
Paint (except mating areas)
M3 screw terminals
See below
Penetration tube plus fixing screws - Optional extra – please ask

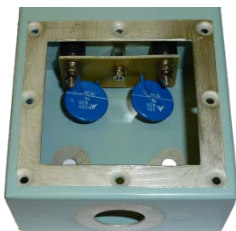



Cable Entry Options

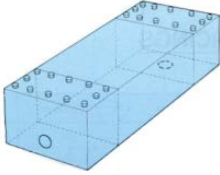

Part No DS XXXXX / C
End entry base exit
(standard cable entry configuration)

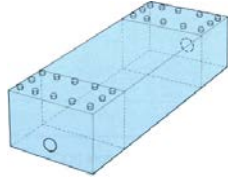

Part No DS XXXXX / A
End entry end exit
(alternative cable entry)

Two different cable entry options are available as shown.
Standard configuration is suffix C for shielded room mounting, i.e. end entry, base exit.
For end entry and end exit, substitute suffix C with suffix A in the part number.

Installation Details



Typical Installation

The mounting surface should be clean and unpainted to ensure a low impedance earth bond and good RF seal.
Fixing screws and gland tubes can be supplied as an optional extra.

Recommended tightening torque figures:

M3 terminals:	0.5N-m
M4 lid fixings:	1N-m

Safety

Relevant safety standards have been adhered to in the design and manufacture of these products. However, all capacitors will store charge after power has been removed and must be treated with respect as a shock can be lethal if the voltage and charge are high enough.

Even though discharge resistors are fitted to this range of filters, terminals should always be shorted to earth prior to touching to ensure the capacitors are fully discharged.

The user should ensure he is familiar with restrictions on capacitance value, earth leakage current, test voltage, and safety labelling requirements, which may be applicable to his particular installation.

These filters must be solidly and permanently earthed, both for safe operation and to achieve optimum EMC and pulse performance.

Custom Designs

MPE offers a rapid design service for custom designs where special packaging, mounting, terminations, or multiple lines are required. Over 50% of the filters manufactured by MPE are custom designs and this can offer a very cost effective installation solution. Please ask to see examples of previously offered solutions.

Filter Selection Guide

Step 1 Choose voltage rating required (28VDC, 48VDC, 120VAC or 250VAC)

Step 2 Choose number of lines required

Step 3 Select part number and cable entry suffix